

SECTION AA

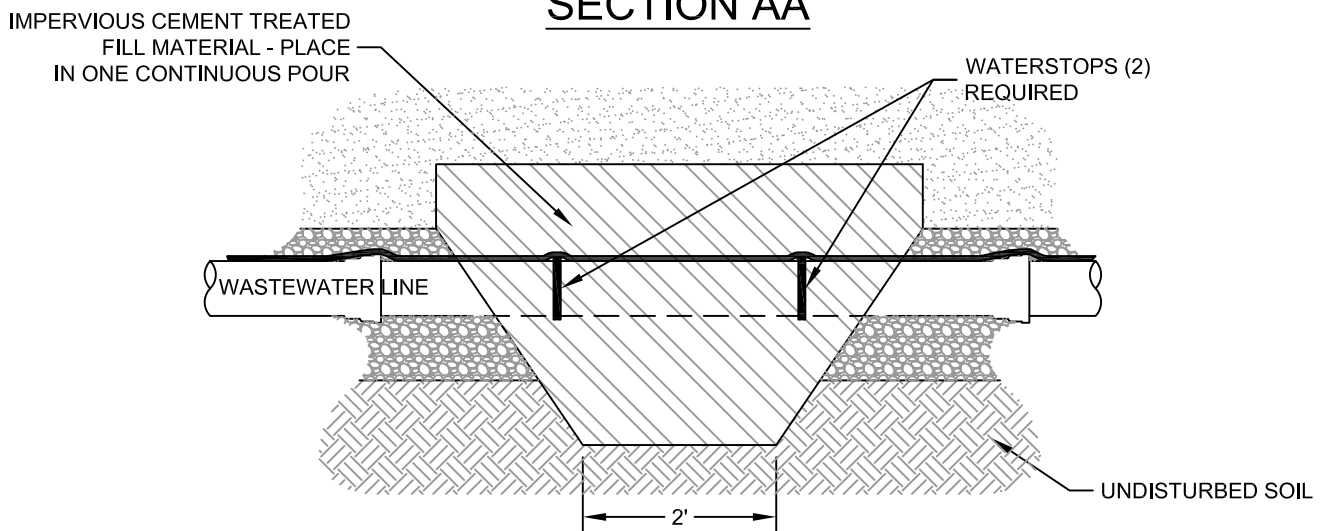

PROFILE

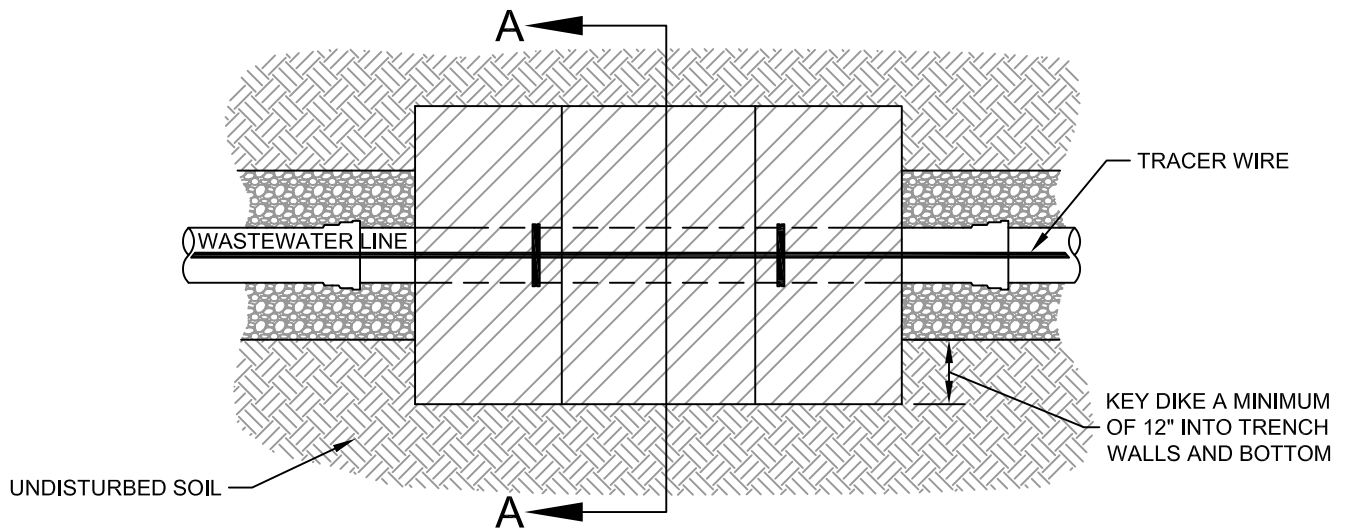

PLAN

TRENCH DIKES REQUIRED AT LOCATIONS AS INDICATED ON APPROVED PLANS OR AS OTHERWISE DIRECTED BY SBWRD



**Snyder Basin Water
Reclamation District**

TRENCH DIKE

STANDARD DETAIL

PI-03

Revision Date: 2/22/16